



Everything but the container

Roll-Off[™]
Parts.com

CATALOG



CATALOG



EXPERIENCED SERVICE

As "Solution Providers," we manufacture over 50 different parts in-house and offer a full service refurbishment program. With over 35 years of experience and little-to-no warranty claims, we take pride in the Roll-off Parts™ craftsmanship.



SUPERIOR SHIPPING

We offer industry leading lead times. With our experience, we provide our customers with reasonable and competitive shipping rates. We are here to serve our customers beyond the sale with continued communications to ensure the customers' satisfactions have been met.



VISIT US
ROLL-OFFPARTS.COM

CONTACT US
855-860-3252

DIAGRAMS

Front Side	4
Rear Side	5

CONTAINER PARTS

Hookups	6
A Frame	7
Side Posts	8
Tailgates	10
Seals and Accessories	12
Wheels	13

SUBFRAMES

Standard Subframes	14
ISO Subframes	14

ACCESSORIES

Tarps	17
Liners	18
Dewatering Baskets	19
Decals	20
Lids	21

SMALL CAN PARTS

Replacement Bottoms	23
Fork Pocket Assembly	23
Lids	23
Side Doors	23

REFURBISH PROGRAM

Services Provided	24
-------------------	----

DIAGRAMS

Front Side

Cable / Hook-lift Combo Shown

Represented below are key components and accessories on both a cable hoist and hook-lift roll-off containers.

Standard roll-off containers utilize the same parts with different configurations in the number of latches and hinges based on container height.

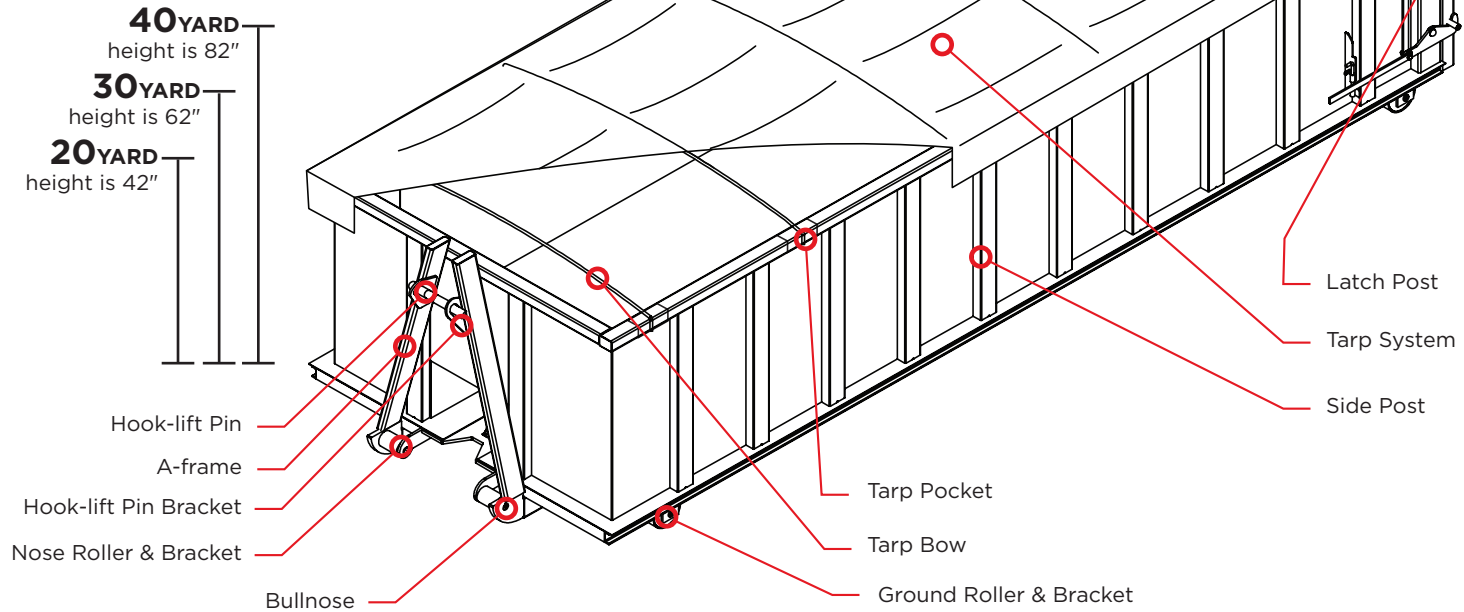

Rear Side

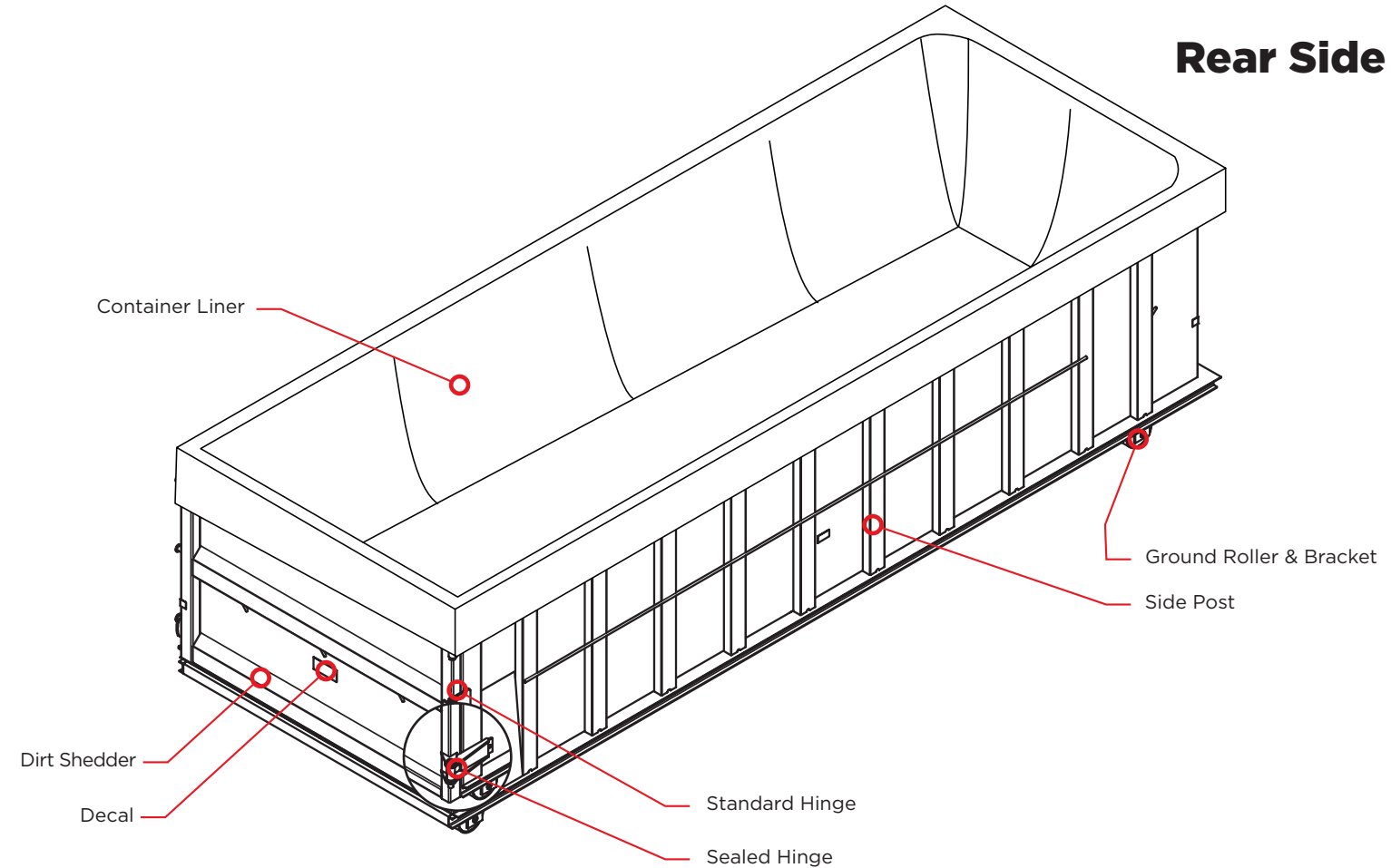

CONTAINER PARTS

Hookups

Hook-lift

Part Number	Name
3080127	1½" Hooklift Pin
3080125	2" Hooklift Pin
3260101	2" Hooklift Pin Bracket
3080128	2½" Hooklift Pin
3260111	2½" Hooklift Pin Bracket



1½" HOOKLIFT PIN
3080127

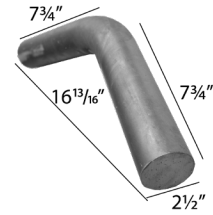

2½" HOOKLIFT PIN
3080128

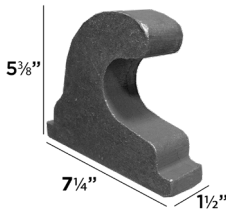

CABLE-STYLE HOOK
3120124

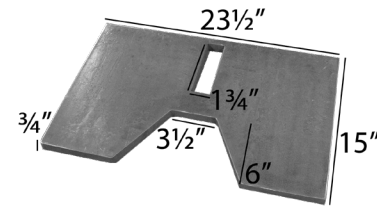

STANDARD ¾" HOOK PLATE
3120125

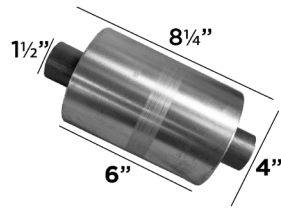

NOSE ROLLER 4"X6" W/ 8¼ AXLE
4070114

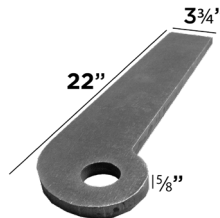

NOSE ROLLER BRACKET
3120127

Cable Hoist

Part Number	Name
3120124	Cable-Style Hook
3120125	Standard ¾" Hook Plate
3120126	Heavy Duty 1" Hook Plate
4070148	Nose Roller 4" X 4" with a 6½" axle
4070114	Nose Roller 4" X 6" with a 8¼" axle
3120127	Nose Roller Bracket
3120129	Bull Nose Bracket

Heil Knuckle

Part Number	Name
3170223	Heil Knuckle Receiver

NORTH AMERICAN
CERTIFIED
STEEL

A Frame



Part Number	Name
4120102	36" Hook-lift A Frame Available with 1½" Hooklift pin
4120103	54" Hook-lift A Frame Options available with 2" or 2½" Hooklift pin
4120104	62" Hook-lift A Frame Options available with 2" or 2½" Hooklift pin

Side Posts

Full Side Posts (*OD 5 1/4 X 2 5/8 - 12GA*)

Part Number	Side Post Lengths
3010332	33" Full Side Post
3010333	39" Full Side Post
3010336	59" Full Side Post
3010338	79" Full Side Post
3010340	93" Full Side Post

33" FULL SIDE POST
3010332



16" REPAIR CAP
3010330

Repair Caps (*ID 5 1/2 X 2 3/4 - 10GA*)

Part Number	Repair Cap Lengths
3010330	10" Side Post Caps
3010329	16" Side Post Caps
3010331	24" Side Post Caps

Manufactured to fit over our side posts.

Custom lengths and sizes available for additional cost. Contact us for more details.



"Solution Providers"
Experienced Craftsmanship



Tailgates

Standard

Part Number	Name
3260118	Standard Door Fork
4040102	Standard Tailgate Hinge
3260118	Standard Latch Ear
4080106	Standard Latch Bracket with Pin & Chain

Sealed

Part Number	Name
3260119	Sealed Door Fork
4040104	Sealed Tailgate Hinge
3260120	Sealed Latch Ear

Components

Part Number	Name
3170221	Ratchet Binder
3260104	Key Hole Bracket
4080110	6" Door Pin
3010686	86" Wide Tailgate Dirt Shedder

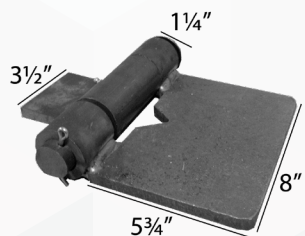

STANDARD TAILGATE HINGE
4040102

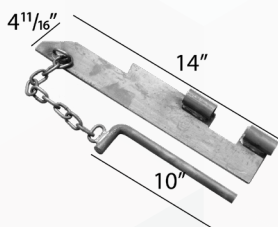

STANDARD LATCH BRACKET WITH PIN & CHAIN
4080106

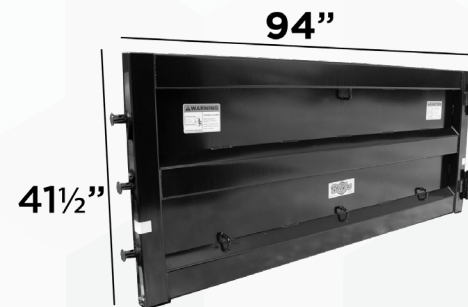

42"X94" 20YD TAILGATE
4050105

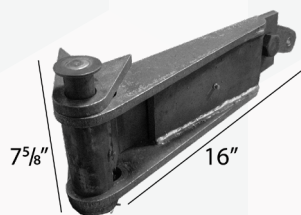

SEALED TAILGATE HINGE
4040104

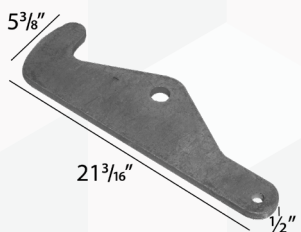

SEALED LATCH EAR
3260120



RATCHET BINDER
3170221

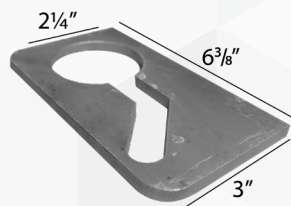

KEYHOLE BRACKET
3260104



79" FULL LATCH POST
4080179



45" FULL LATCH POST
4080145

Standard Tailgates

Part Number	Name
4050105	42"x94" 20YD Tailgate
4050108	52"x94" 25YD Tailgate
4050107	62"x94" 30YD Tailgate
4050110	72"x94" 35YD Tailgate
4050109	82"x94" 40YD Tailgate
4050111	92"x94" 45YD Tailgate
4050112	96"x94" 50YD Tailgate

Tailgates do not come with hinges and pins attached. Custom sizes and sealed tailgates also available. Prime and paint options available for additional cost.

Full Latch Posts

Part Number	Side Post Sizes	Latch Ears	Container Height ^(ft)
4080139	39" Full Latch Post	2	42"
4080145	45" Full Latch Post	2	48"
4080149	49" Full Latch Post	2	52"
4080159	59" Full Latch Post	2	62"
4080169	69" Full Latch Post	2	72"
4080179	79" Full Latch Post	3	82"
4080189	89" Full Latch Post	4	92"
4080193	93" Full Latch Post	4	96"

Full Latch Posts come fully manufactured with standard latch ears, linkage bar and handle.

Seals and Accessories

Seal Types

Part Number	Name
3170184	E-seal
3170840	T-seal
3170186	P-seal*
3140102	48" P-seal Track
3140104	96" P-seal Track
3170241	*Multi-Seal® Adhesive

The seals come standard in 1-foot lengths.
*Components that must accompany P-Seal.



E-SEAL
3170184



T-SEAL
3170840



P-SEAL
3170186

Looking to replace more seal?
Full 250ft rolls are available



MULTI-SEAL®
3170241



48" P-SEAL TRACK
3140102

Wheels

Wheel with Axle

Part Number	Wheel Size (Diameter x Width)	Grease Zerks
4070150	8" Diameter X 8" Width wheel w/ 11" axle	1
4070134	8" Diameter X 6" Width wheel w/ 9" axle	1
4070141	6" Diameter X 6" Width wheel w/ 9" axle	1
4070142	6" Diameter X 10" Width wheel w/ 13" axle	1

Wheel with Bracket Assembly

Part Number	Build Grade	Wheel Size (Diameter x Width)	Bracket Size	Grease Zerks
4070139	Standard Duty	6" x 6" Wheel	5" x 7"	1
4070128	Standard Duty	6" x 6" Wheel	5" x 8"	1
4070124	Standard Duty	8" x 6" Wheel	5" x 7"	1
4070135	Heavy Duty	8" x 6" Wheel	5" x 7"	1
4070123	Standard Duty	8" x 6" Wheel	5" x 7"	2
4070125	Standard Duty	8" x 6" Wheel	5" x 8"	1
4070120	Standard Duty	8" x 10" Wheel	5" x 7"	1
4070136	Heavy Duty	8" x 10" Wheel	5" x 7"	1
4070121	Standard Duty	8" x 10" Wheel	5" x 8"	1
4070119	Standard Duty	8" x 10" Wheel	5" x 7"	2

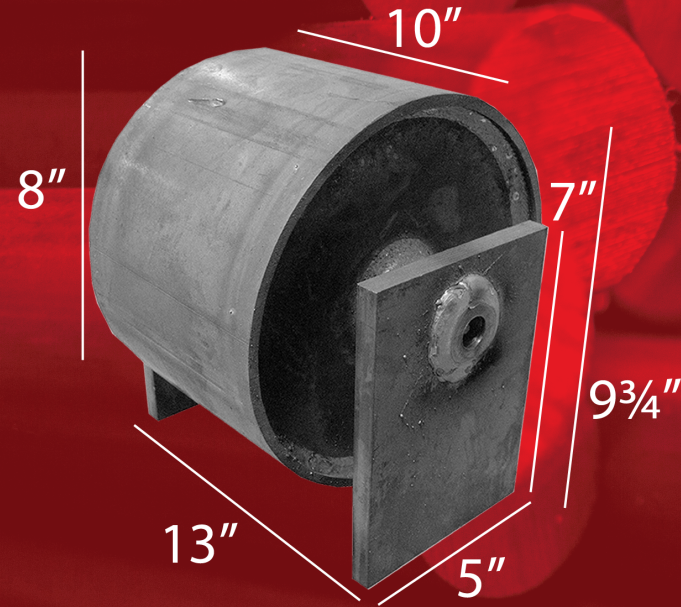

8" X 10" WHEEL WITH 5" X 7" BRACKET
4070120

SUBFRAMES

Standard Subframes

Whether you want to convert your hookup or upfit your truck with specialized equipment, our built-to-order subframes are the ideal solution. Standard lengths available from 8-22ft. Wheels ship loose.



ISO Subframes

Our ISO Subframes are the ideal solution to convert your ISO Land Sea container into a roll-off container. Lengths available in 20 and 40ft. Wheels ship mounted.



All subframes come standard with primer. Paint is available for an additional cost.

Hook-lift Style

HOOK-UP PIN

1½" | 2" | 2½"

36" | 54" or 62"

BAIL HEIGHTS

36" | 54" | 62"

STANDARD

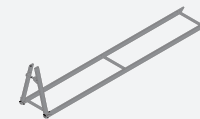

ISO CONTAINER

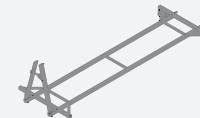

Cable Style

HOOK PLATE

¾" | 1"

STANDARD

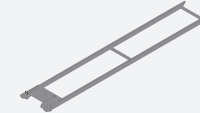

ISO CONTAINER

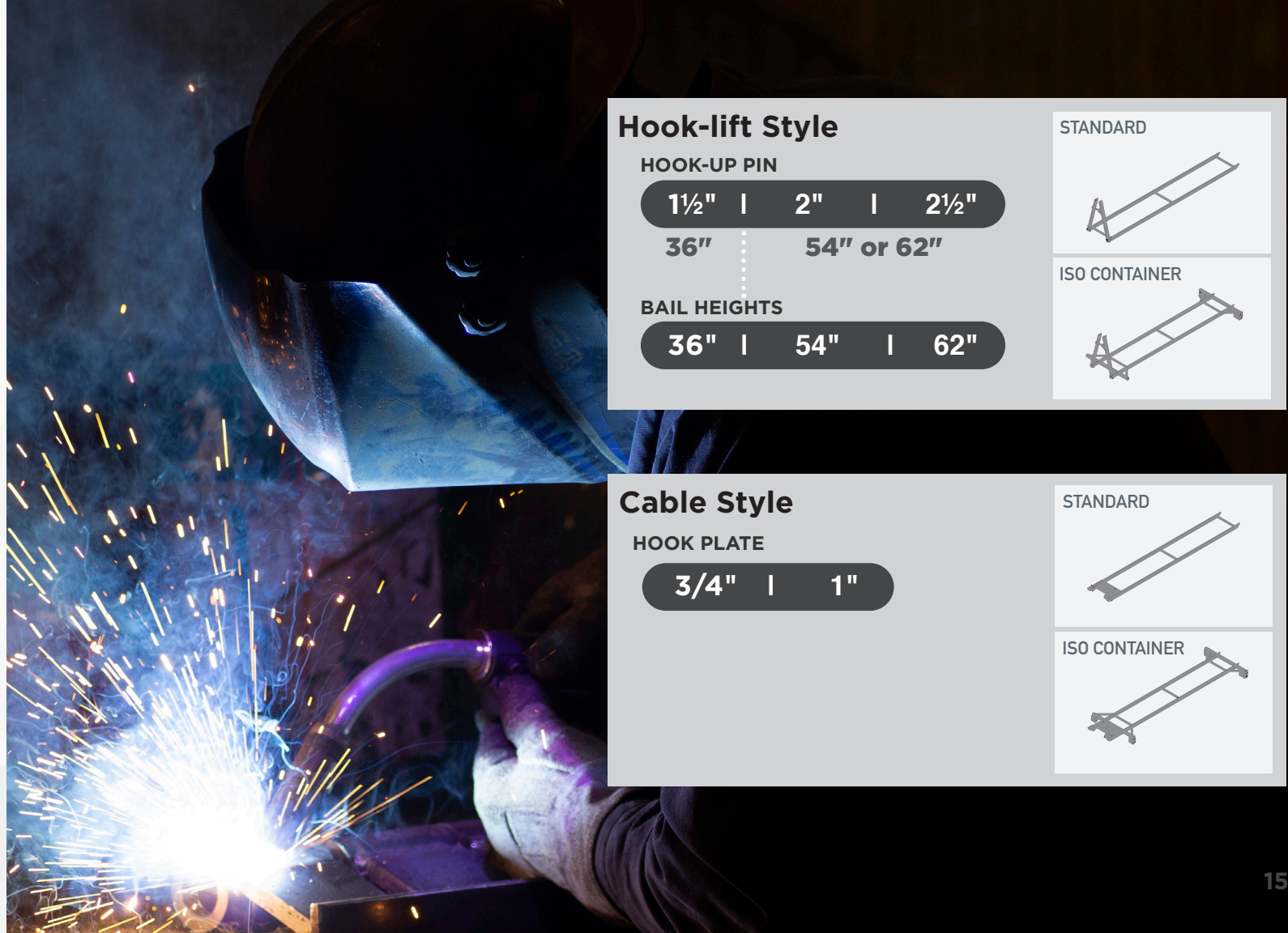

ACCESSORIES



22' VINYL SIDE ROLL TARP SYSTEM
3270101



22' VINYL THROW TARP KIT
3270124



22' VINYL SIDE ROLL TARP WITH STRAPS
3270116

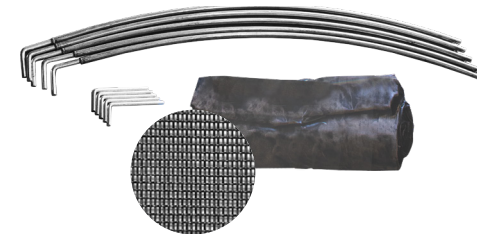

22' MESH THROW TARP KIT
3270102

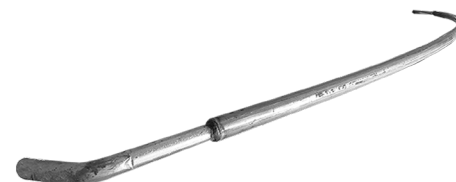

TARP BOW
3270100



REMOVABLE TARP POCKET
4100110

Tarps

Tarp Kits

Part Number	Name
3270101	22' VINYL SIDE ROLL TARP SYSTEM
3270124	22' VINYL THROW TARP KIT
3270102	22' MESH THROW TARP KIT
3270116	22' VINYL SIDE ROLL TARP W/ STRAPS

Tarp Accessories

Part Number	Name
3270100	Tarp Bow
4100110	Removable Tarp Pocket

Liners

20 Yard Plastic Liners

Part Number	Name	Unit Qty.
1300103	22' X 8' X 5' 3MIL Plastic Liner	SET OF 4
1300104	22' X 8' X 5' 4MIL Plastic Liner	SET OF 4
1300102	22' X 8' X 5' 6MIL Plastic Liner	SET OF 2

30 Yard Plastic Liners

Part Number	Name	Unit Qty.
1300106	22' X 8' X 6' 4MIL Plastic Liner	SET OF 4
1300108	22' X 8' X 6' 6MIL Plastic Liner	SET OF 2
1300110	22' X 8' X 6' 10MIL Plastic Liner	SET OF 2

20 Yard Dewatering Liners

Part Number	Name	Unit Qty.
1310102	22' X 8' X 6' 400 Micron Knit Mesh Liner	
1310101	22' X 8' X 6' 250 Micron Screen Mesh Liner	
1310100	22' X 8' X 6' 130 Micron Cloth Liner	

30 Yard Dewatering Liners

Part Number	Name	Unit Qty.
1310105	22' X 8' X 8' 400 Micron Knit Mesh Liner	
1310104	22' X 8' X 8' 250 Micron Screen Mesh Liner	
1310103	22' X 8' X 8' 130 Micron Cloth Liner	



22' X 8' X 5' 3MIL PLASTIC LINER
1300103

SEE THE DIFFERENCE



HEAVY DUTY PLASTIC LINER

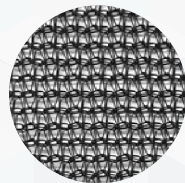

400 MICRON KNIT MESH

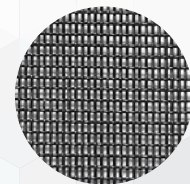

250 MICRON SCREEN MESH

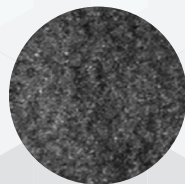

130 MICRON CLOTH

Dewatering Baskets

STANDARD

Dewatering Baskets come primed. Paint is available for additional cost.

Custom options and epoxy coatings available.

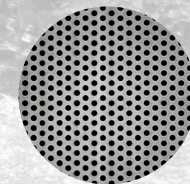
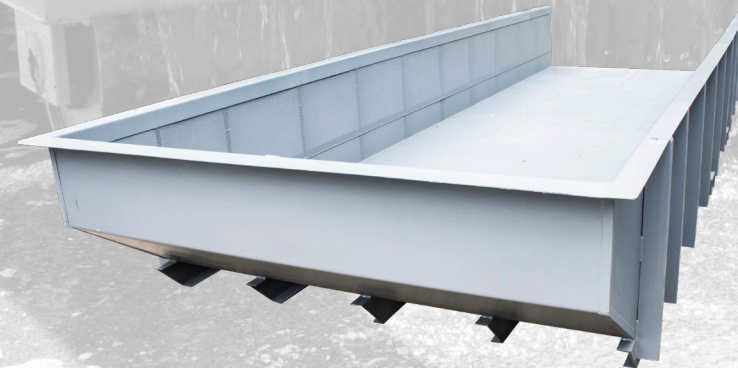
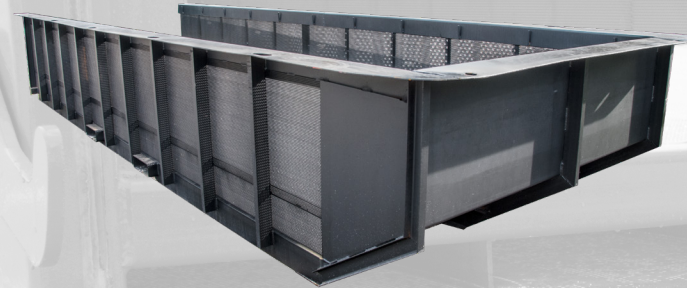

PERFORATED STEEL

Decals

Part Number	Name
3240112	Caution Decal (Falling Hazard)
3240113	Warning Decal (Striking Hazard)
3240116	Relieve Tank Pressure Decal
3240114	DOT C2 Red & White Tape (150' Roll)



**CAUTION DECAL
(FALLING HAZARD)**
3240112



**WARNING DECAL
(STRIKING HAZARD)**
3240113



**DANGER DECAL
(RELIEVE TANK PRESSURE)**
3240116

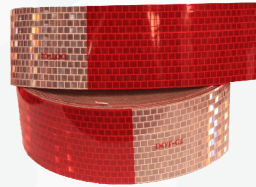

DOT C2 RED & WHITE TAPE
3240114

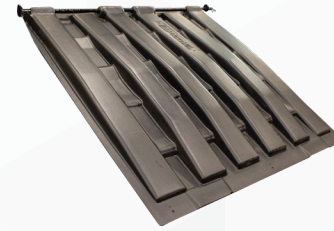

PLASTIC HINGED LID
3280116



PLASTIC SLIDING LID
3280112



PIVOTING ROLL-OFF LID SYSTEM
3280102



WING NUT & BOLT COMBO
3170224

Lids

Part Number	Name
3280116	Plastic Hinged Lid (31" x 31")
3280112	Plastic Sliding Lid (30" x 30")
3280102	Pivoting Roll-Off Lid System

Miscellaneous Parts

Part Number	Name
3170224	Wing Nut & Bolt Combo

SMALL CAN PARTS

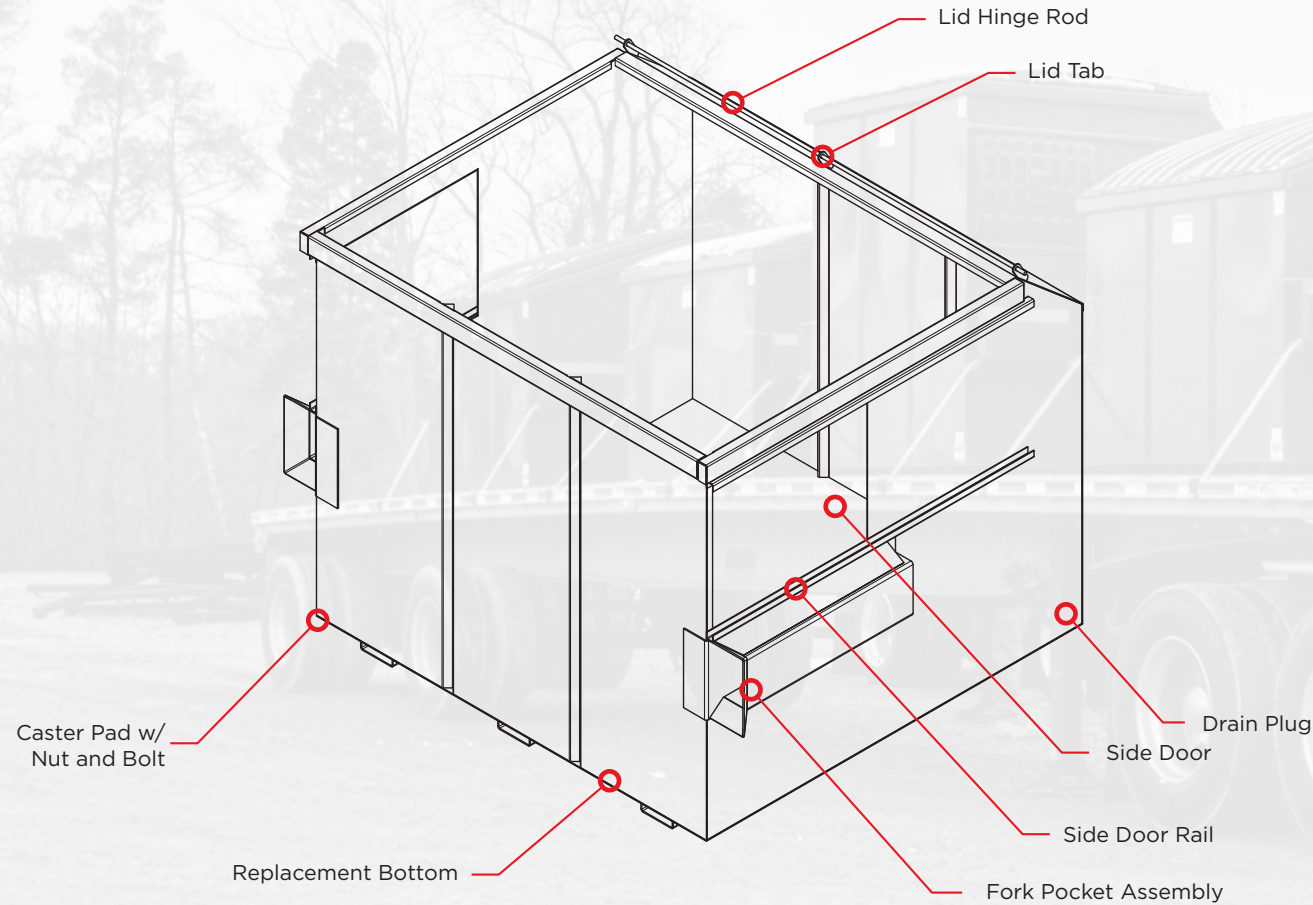

Lids

Part Number	Name
3280113	36"x41" Front Load Lid - 2YD Slant and Flat
3280108	36"x48" Front Load Lid - 4YD Flat Only
3280104	36"x58" Front Load Lid
30000133	1/2" Galvanized Lid Hinge Rod
3260499	Small Can Lid Tab

Side Doors

Part Number	Name
3280112	30"x30" Sliding Side Door
3280101	30"x24" Sliding Side Door
3011832	Side Door Rail

Miscellaneous Parts

Part Number	Name
3160466	3/4" Drain Plug
3000131	4x4 Caster Pad w/ Nut & Bolt

Fork Pocket Assembly

Part Number	Name
4000120	Right Fork Pocket Assembly
4000121	Left Fork Pocket Assembly

Replacement Bottoms

Replacement Bottoms are available for all small cans ranging from 2-10YD by call-in only. Have dimensions ready for quick and efficient ordering.



**REPLACEMENT BOTTOM
10 GAUGE**



NEED MORE THAN JUST A FEW PARTS?

Restoring containers on your own or via a local fabrication shop can be a hassle. Let us handle the stress and the mess of our full service refurbishment program.



SERVICES PROVIDED

- Side Posts
- Damaged Sides
- Tailgates
- Hinges
- Seals and Tracks
- Wheels
- Nose Rollers
- Floors
- Prime and Paint
- Fire Damage
- Subframes
- A-Frames
- Additional Features
- and more

*Scan to
receive a
quote today.*



SMALL TOWN
MADE
HADLEY, PA

 roll-offparts.com

 855•860•3252

 info@roll-offparts.com

Division of **Deist**
INDUSTRIES, INC